

SYMPL FUSION DMX512 Module 2 Ports

Information for Use

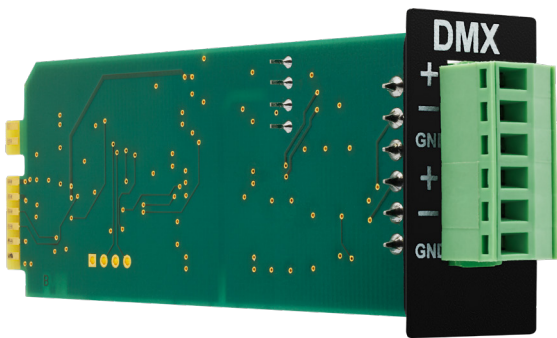

SYMPL FUSION

Read the Information for Use and the Safety Instructions carefully. Subject to modification without prior notice.

Typographical and other errors do not justify any claim for damages. Modification of the product is prohibited.

This document is designed for electricians and system administrators of the product.

All product names and trademarks mentioned in this manual are trademarks of their respective owners.

Except for internal use, relinquishment of the instructions to a third party, duplication in any type or form - also extracts - as well as exploitation and / or communication of the contents is not permitted.

Downloads and more information at:
www.ecue.com

IC: CL24100604235

Edition:

12.05.26 [EN_SYMPL_Fusion_module_DMx2CH_Setup_v1p1]

Published by:

Traxon Technologies Europe GmbH
Im Dörener Feld 8
33100 Paderborn, Germany

©2026 Traxon Technologies Europe GmbH
All rights reserved

Traxon Technologies Europe GmbH
Sales Operations
Im Dörener Feld 8
33100 Paderborn, Germany
+49 5251 54648-0
support@ecue.com

Table of Contents

1	Safety instructions	1
1.1	Symbols	1
1.2	General safety instructions	1
2	General device description	1
2.1	Delivery content	1
3	General remarks	2
3.1	Transport	2
3.2	Unpacking	2
3.3	Warranty regulations	2
3.4	Maintenance and Repair	2
3.5	Disposal	2
3.6	Support	3
4	Interfaces	3
4.1	Connectors and Interfaces	3
4.2	User interface: LEDs	4
5	Product specifications	4
6	Installation	5
6.1	DMX connection	5
6.2	Insert Module	5
7	Module Configuration	6
7.1	Optional: Unassigned modules in the project	6
7.2	Making modules available for configuration	7
7.3	Return of control	8
8	Test Mode	8
9	Dismounting	9
10	Certifications	9

1 Safety instructions

Please read and follow the safety instructions, provided in a separate manual, carefully. Make sure that the environmental, mounting, and installation prerequisites are met. This manual should be kept at a safe place and in reach of the device.

1.1 Symbols



The exclamation mark warns about possible damage of the device itself, to connected devices, and to the user.



The information symbol gives general hints and informs about handling and procedures for use of the device.

1.2 General safety instructions



- Connect the module, cables and data only when the SYMPL FUSION Base Device is powered down.



- If safety instructions are missing, please contact Traxon e:cue to receive a new copy.

2 General device description

Whatever setup your project requires, the SYMPL Fusion always has the right configuration at hand. The modular slot card concept allows the freedom to compose your individual demands. The SYMPL FUSION DMX512 Module 2 Ports offers two DMX512 universes including RDM functionality, integrating DMX components into your system.

Highlights

- 2 x DMX512 / RDM universe

More information about the SYMPL Fusion system and the SYMPL FUSION Base Device:

<https://eu.traxon-ecue.com/products/syml-fusion/>



2.1 Delivery content

Delivery content of the e:cue SYMPL FUSION DMX512 Module 2 Ports - Product number CL24100604235

1. SYMPL FUSION DMX512 Module 2 Ports
2. Welcome card
3. DMX connector, 3-pin (Würth 691 3611 00006)
4. 1 x Bezel
5. 1 x Screw.

3 General remarks

3.1 Transport

Only transport the device in its original packaging. This protects the device from damage.

3.2 Unpacking

Only unpack the device at its installation location. To protect the device against condensation water, unpack it and wait until all moisture remaining in the device has evaporated. Condensation can occur when the device is moved from a cold to a warm location. Keep the packaging for use in case of further transport. Inspect all parts for completeness regarding chapter “2.1 Delivery content” (page 1). If there is apparent damage to the device or parts are missing from the delivery scope, please contact the Traxon e:cue support service.

3.3 Warranty regulations

Depending on the product, warranty regulations are of different duration. The warranty time is usually noted in the quote and in the order confirmation. See www.traxon-ecue.com/terms-and-conditions for details. Legal warranty regulations apply in any case.

3.4 Maintenance and Repair

This device requires no maintenance.



- Before dismounting, appropriate measures must be taken to protect the respective components against damage caused by electrostatic discharge (ESD protection).
- Do not try to repair the device. Return it to your Traxon e:cue distributor for replacement or repair.

To update the firmware see the Information of Use of the SYMPL FUSION Base Device.

3.5 Disposal



Batteries and technical appliances must not be disposed of with domestic waste, but should be handed in at the appropriate collection and disposal points.

The proper disposal of packing materials and of the device is the responsibility of the respective user and for his account; in all other matters, the retrieval obligation for packing materials and the device is subject to the statutory regulations.



3.6 Support

In case of technical problems or questions regarding installation and repair please contact:

Traxon Technologies Europe GmbH
 Customer Service
 Im Dörener Feld 8
 33100 Paderborn, Germany
 +49 (5251) 54648-0
 support@ecue.com

4 Interfaces

4.1 Connectors and Interfaces

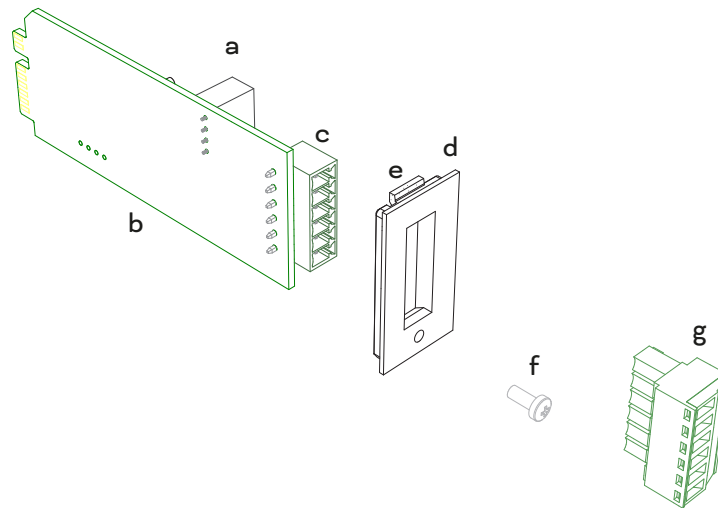

a	Module	
b	Bare side of module	
c	Plug	Fixed to the module, counterpart of connector.
d	Bezel	Module specific capping.
e	Hook	Holds the top edge of the module's bezel connected to the SYMPL FUSION Base Device.
f	Screw	To fasten the module's bezel.



g DMX connector 2 x DMX512/RDM (DMX +, DMX -, GND top to bottom; universe 1 top, universe 2 bottom)
 Further installation details: [“6.1 DMX connection” on page 5](#)



4.2 User interface: LEDs

The slot in which the module is inserted has a corresponding LED. This slot LED on the SYMPL FUSION Base Device indicates different states of the SYMPL FUSION DMX512 Module 2 Ports:

Slot LED	Status
Off	No DMX output
Yellow, static	DMX module ready
Yellow, flickering	DMX output
Green	DMX/RDM input
Red, static	Error
Red, blinking	Test mode active

5 Product specifications

IC	CL24100604235
Weight	14 g / 0.03 lb
Power supply input	from SYMPL Fusion base device
Operating temperature	-20 ... 40 °C / -4 ... 104 °F
Storage temperature	-20 ... 70 °C / -4 ... 158 °F
Op. / Stor. humidity	0 ... 80% RH, non-condensing
Certificates	CE, ETL

Interface specifications

Output interfaces	2 x DMX512 3-pin terminal plug wire gauge: 0.3 ... 1.3 mm ²
-------------------	--



6 Installation

The installation of the SYMPL FUSION DMX512 Module 2 Ports consists of installing the module into the SYMPL FUSION Base Device and connections to DMX fixtures.



Install the module and connect cables only when the SYMPL FUSION Base Device is powered down.

6.1 DMX connection

The SYMPL FUSION DMX512 Module 2 Ports offers a 2 x 3-pin assigned screw terminal plug for the two DMX512 / RDM universes. Use a screw driver to open and close the terminal for attaching the wires. Connect the wires according to the pin assignment on the label.

The appropriate pin assignment is defined as follows:

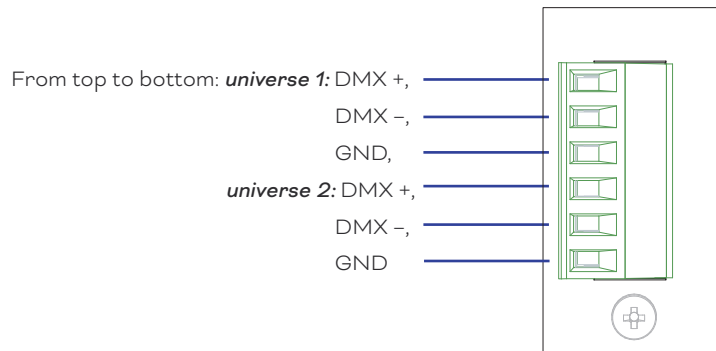

- It is recommended to use twisted pair cabling.
- DMX connection cable length \leq 300 m.

6.2 Insert Module

The modular slot card concept allows the freedom to compose your individual demands. The SYMPL FUSION Base Device can control four modules in any combination.

Insert a module into a slot and fix the module with a screw to the base device. For further information see the Information for Use of the SYMPL FUSION Base Device.

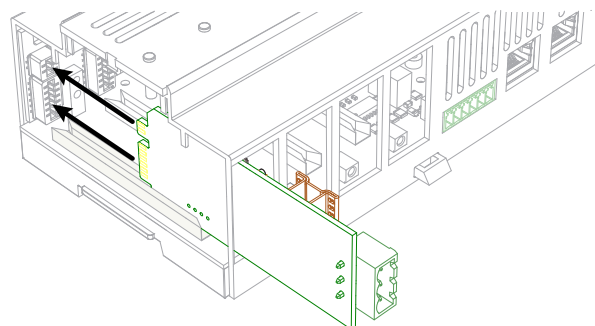

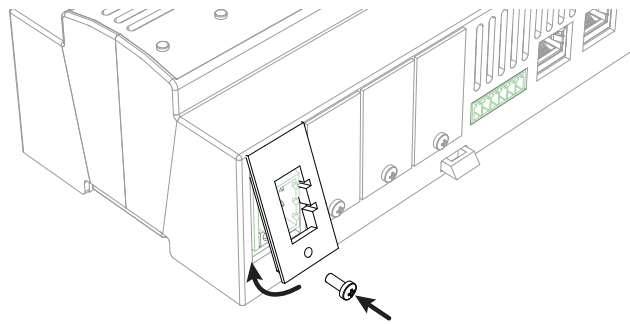

Do not insert or remove modules while the device is powered on.

7 Module Configuration

The module has properties that are configurable in Sympholight. The configurable properties of a SYMPL FUSION DMX512 Module 2 Ports are:

DMX 1:

Select the DMX universe for the module's DMX 1 port.

Address Mapping		
DMX 1	U1	X + ▾
DMX 2	U2	X + ▾

DMX 2:

Select the DMX universe for the module's DMX 2 port.

The modules are handled the same way as other devices in Sympholight and are listed in the Device Manager - Offline devices.

Starting point

Open the Sympholight software and your project file.

7.1 Optional: Unassigned modules in the project

1. Place unassigned modules in the project according to your needs.
2. Configure the properties of the modules. See the individual instruction for each module type.
3. Set the slot number in which the corresponding module type is installed in the SYMPL FUSION Base Device. Leave it at 0 to prevent direct assignment when modules become available in the next chapter.



7.2 Making modules available for configuration

1. Open the context menu of the SYMPL FUSION Base Device.
2. Select “Redirect modules and input events to this instance”.

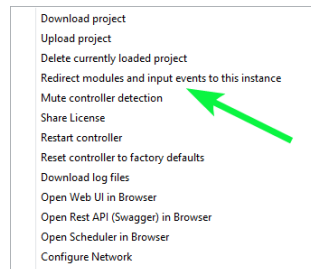

The status box of the SYMPL FUSION Base Device and the Status LED turn blue indicating the redirection. 

- The modules are now either directly assigned to the pre-arranged modules when the module types in the slot numbers matches.

Example: You have an unassigned place holder of type DALI module that is set to slot number 3. The real DALI module in slot 3 of the SYMPL Fusion is assigned to this place holder and takes over its properties.

Place holder:

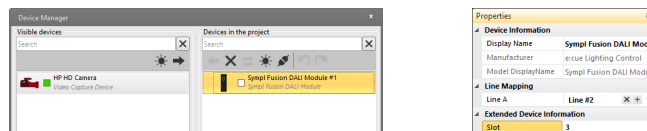

Place holder is automatically replaced by real module of the same slot. The real module applies the pre-configured properties of the place holder:

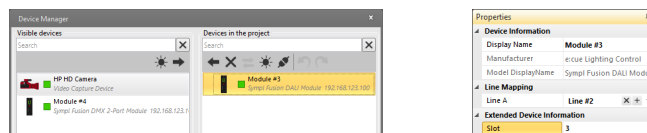

- Or the modules are available in the Device Manager - Online devices. Drag & drop them into the project and configure their properties now.

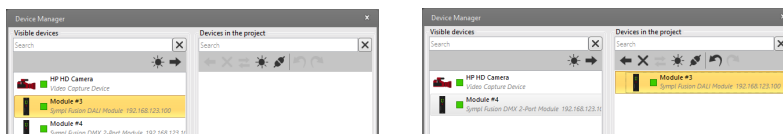

- Unassigned modules with slot number 0 can be assigned to a real module of matching type when you set the slot number to an yet unmatched module.



7.3 Return of control

To complete the modules configuration, return the control over them back to the SYMPL FUSION Base Device. To cancel the redirection, click “Disconnect” in the main menu bar

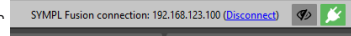

Alternatively, open again the context menu of the SYMPL FUSION Base Device and select “Give back the modules and input access to the device”.

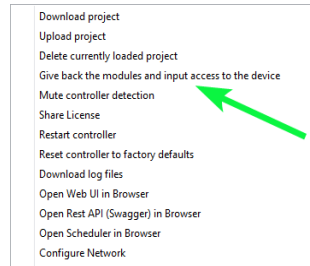

Upon uploading a project file to the SYMPL FUSION Base Device and clicking “Handover & Close”, the control over the modules also returns back to the SYMPL Fusion.

The status box of the SYMPL FUSION Base Device turns back to green indicating the full control of the device.

8 Test Mode

The following test patterns are available for the SYMPL FUSION DMX512 Module 2 Ports - both via Test Mode Pattern button (and Pattern button)

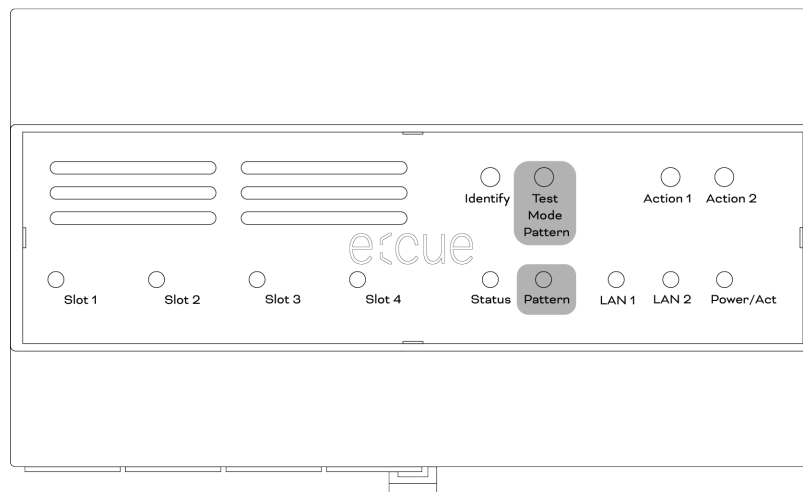

and via web interface of the SYMPL FUSION Base Device.

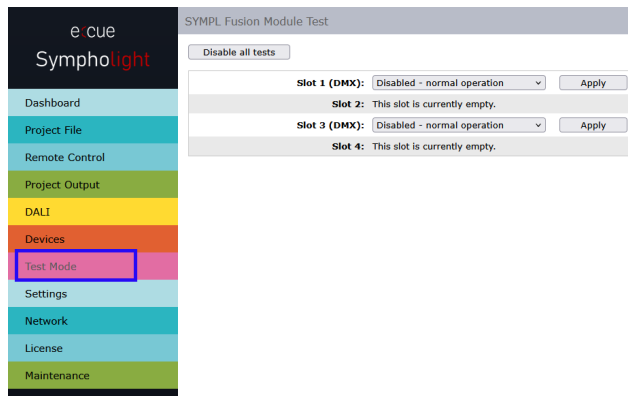

For further information see the Information for Use of the SYMPL FUSION Base Device.

Test pattern	DMX output	Pattern LED
1	Full on	Blue static
2	Snake	Green static
3	Flash	Violet static
4	Off	Off
Web interface only	Fade up/down	

9 Dismounting

For dismantling information see the Information for Use of the SYMPL FUSION Base Device.



- Before dismounting, appropriate measures must be taken to protect the respective components against damage caused by electrostatic discharge (ESD protection).
- Do not insert or remove modules while the device is powered on.

10 Certifications



Conforms to ANSI/UL Std. 62368-1
 Certified to CSA Std. C22.2 NO. 62368-1

