

Glass Touch GT12X

Installation Guide



Read the Installation Guide and the Safety Instructions carefully. Subject to modification without prior notice. Typographical and other errors do not justify any claim for damages. Modification of the product is prohibited.

This document is designed for electricians and system administrators of the product.

All product names and trademarks mentioned in this manual are trademarks of their respective owners.

Except for internal use, relinquishment of the instructions to a third party, duplication in any type or form - also extracts - as well as exploitation and / or communication of the contents is not permitted.

Downloads and more information at:
www.ecue.com

IC: CL25100005435, CL25100008135, CL25200008035

Edition:
29.04.26 [EN_GlassTouchT12X_Installation_v1p4]

Published by:
Traxon Technologies Europe GmbH
Im Dörener Feld 8
33100 Paderborn, Germany

©2026 Traxon Technologies Europe GmbH
All rights reserved

Traxon Technologies Europe GmbH
Sales Operations
Im Dörener Feld 8
33100 Paderborn, Germany
+49 5251 54648-0
support@ecue.com

Table of Contents

1	Safety instructions	03	
	1.1 Symbols		03
	1.2 General instructions		03
2	General device description	03	
	2.1 Delivery content		04
	2.2 Optional accessories		04
	2.3 Product specifications		05
3	General remarks	06	
	3.1 Transport		06
	3.2 Unpacking		06
	3.3 Warranty regulations		06
	3.4 Maintenance and Repair		06
	3.5 Support		06
	3.6 Cyber security		07
4	Connectors and interfaces	07	
	4.1 User interfaces		08
	4.2 Connections		09
5	DIP switch: Protocol Selection & Addressing	10	
6	Wiring System	10	
7	Power supply	12	
8	Paper / plastic sheet insert	13	
9	Mounting	15	
10	Configuration	17	
	10.1 DALI-2 in Sympholight		17
	10.2 e:bus2 in LAS		19
11	Cleaning	20	
12	Dismounting	21	
13	Certifications	22	
14	Dimensions	22	
15	Troubleshooting	23	
16	FAQ	24	

1 Safety instructions

Read the safety instructions, provided in a separate manual, carefully. Make sure that the environmental, mounting, and installation prerequisites are met. This manual should be kept at a safe place and in reach of the device.

1.1 Symbols



The exclamation mark warns about possible damage of the device itself, to connected devices, and to the user.



The information symbol gives general hints and informs about handling and procedures for use of the device.

1.2 General instructions



- Glass surface. Handle with care to avoid breakage or injuries.
- Do not install in locations where collision is likely.
- Replace the device if the glass surface is cracked or damaged.
- Clean with a soft cloth and non-abrasive cleaners to avoid scratching the glass surface.
- The DALI and e:bus2 ports of the Glass Touch GT12X are not designed for inter-building connections. Use the Glass Touch GT12X only with intra-building networks.



If safety instructions are missing, please contact Traxon e:cue to receive a new copy.

2 General device description

The Glass Touch GT12X is a user terminal featuring a modern design with a glass surface and touch-sensitive keys for intuitive operation. It supports both the DALI-2 protocol and the Butler XT3 via the e:bus2 protocol.

Suitable for a variety of high-end lighting applications—including hotel rooms, offices, conference spaces, residential settings, and cruise ships—the Glass Touch GT12X combines functionality with a clean aesthetic.

The device is wall-mountable and supports the connection of up to 8 units via e:bus2, using flexible wiring topologies such as daisy chain or star.



Main features:

- 13 touch-sensitive sensor keys plus 1 palm (hand) function
- Status LEDs on each key with LED button feedback for clear, responsive interaction
- Lock/unlock function via key combination for safe cleaning
- Acoustic feedback (beeper) can be switched ON or OFF
- Flexible glass design options
- Available in five elegant variants:
 - White or black glass with empty key areas for custom labeling
 - White or black glass with numbered keys
 - Fully custom-printed glass for a unique, tailored appearance
- Easy custom labeling:
 - Design your own text and symbols
 - Insert printed labels using the integrated label tray
- DALI-2 certified
- Supports e:bus2 protocol (not compatible with older e:bus systems)
- Fits standard in-wall electrical boxes
- Powered via DALI-2 or e:bus2 (no separate power supply required)
- Topology-free cabling with simple 2-wire power and data connection
- Supports daisy chaining of up to 8 devices via e:bus2

2.1 Delivery content

Delivery content for the e:cue Glass Touch GT12X:

- | | |
|---|---------------|
| 1. Glass Touch GT12X White - Custom labeling | CL25100005435 |
| 2. Glass Touch GT12X Black - Custom labeling | tba |
| 3. Glass Touch GT12X White - Fixed Number Layout | CL25100008135 |
| 4. Glass Touch GT12X Black - Fixed Number Layout | tba |
| 5. Glass Touch GT12X - Custom Print | CL25200008035 |
| 6. Mounting plate | |
| 7. Hex wrench | |
| 8. Default plastic sheet insert (only CL25100005435) and blank insert sheet for self-printing | |
| 9. Safety instructions | |
| 10. Welcome note | |

2.2 Optional accessories

- | | |
|--------------------------------------|---------------|
| • Butler XT3 | CL24100004935 |
| • SYMPL Fusion | CL24100603935 |
| with SYMPL Fusion DALI-2 Module 1Ch. | CL24100604035 |
| • SYMPL dali Node | AB444230035 |

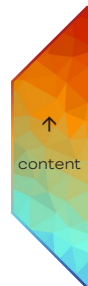

2.3 Product specifications

GTIN	4897135737477
Dimensions (W x H x D)	80 x 160 x 12 mm / 3.15 x 6.3 x 0.47 in
Weight	200 g (incl. mounting plate)
Power supply	via DALI-2 bus or e:bus2 (2-wire cabling)
Power consumption	0.15 W max.
Operating temperature	0 ... 45 °C / 32 ... 113 °F
Storage temperature	-20 ... 75 °C / -4 ... 167 °F
Op. / Stor. humidity	0 ... 80% RH, non-condensing
Ingress protection	IP40
Housing	Glass (surface) Aluminium (mounting plate) ABS (housing body) UV, scratch and cleaning detergent resistant
Mounting	In standard in-wall fitting
Certificates	CE, DALI-2, FCC, ETL

Interface specifications

Interfaces	2 x DALI-2 or e:bus2 (not e:bus compatible!)
Addresses	1
DALI-2 power consumption	4 mA typical, max. 10 mA
User interfaces	13 x capacitive touch sensor 13 x feedback LED (monochrome red, protocol controlled) Rotary DIP switch (protocol selection, e:bus2 addressing)
Beeper	Acoustic feedback

Terminals

Connection type	Push-In
Wire size solid core, stranded wire without end ferrule	0.2 ... 1.5 mm ² (AWG24 ... AWG16)
Wire size stranded wire with end ferrule	0.2 ... 0.75 mm ² (AWG24 ... AWG19)
Stripping length	8 mm / 0.31 in
Tightening/ release of wire	Push button

DALI - further detail:

maximum DALI start-up time: $t = 450$ ms

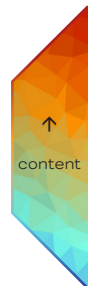

3 General remarks

3.1 Transport

Only transport the device in its original packaging. This protects the device from damage.

3.2 Unpacking

Only unpack the e:cue Glass Touch GT12X at its installation location. To protect the device against condensation water, unpack it and wait until all moisture remaining in the device has evaporated. Condensation can occur when the device is moved from a cold to a warm location. Keep the packaging for use in case of further transport. Inspect all parts for completeness regarding chapter „2.1 Delivery content“ on page 04. If there is apparent damage to the device or parts are missing from the delivery scope, please contact the Traxon e:cue Support service.

3.3 Warranty regulations

Depending on the product, warranty regulations are of different duration. The warranty time is usually noted in the quote and in the order confirmation. See www.traxon-ecue.com/terms-and-conditions for details. Legal warranty regulations apply in any case.

3.4 Maintenance and Repair

This device requires no maintenance. No serviceable parts inside.



- Before dismounting, appropriate measures must be taken to protect the respective components against damage caused by electrostatic discharge (ESD protection).
- Do not try to repair the device. Do not open the device. Return it to your Traxon e:cue distributor for replacement or repair.

Disposal

The proper disposal of packing materials and of the device is the responsibility of the respective user and for his account; in all other matters, the retrieval obligation for packing materials and the device is subject to the statutory regulations.

3.5 Support

In case of technical problems or questions regarding installation and repair please contact:

Traxon Technologies Europe GmbH
Customer Service
Im Dörener Feld 8
33100 Paderborn, Germany
+49 (5251) 54648-0
support@ecue.com

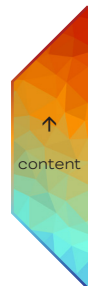

3.6 Cyber security



Cybersecurity disclaimer

In order to protect building automation systems, plants, systems, machines and networks against cyber threats, it is necessary to implement – and continuously maintain – a holistic, state-of-the-art security concept. Traxon's product portfolio including this product you are about to install only forms one element of such a concept. Keep into account that Traxon's products including the product you are about to install contain the ability of third parties to connect to the device via USB, wired and wireless network interfaces.

You are responsible for preventing unauthorized access to your building automation system, plants, systems, machines and networks which should only be connected to an enterprise network or the internet if and to the extent such a connection is necessary and only when appropriate security measures (e.g. firewalls and/or network segmentation) are in place. Additionally, Traxon's guidance on appropriate security measures should be taken into account.

Traxon's portfolio undergoes continuous development to make it more secure.

Traxon strongly recommends that updates are applied as soon as they are available and that the latest versions are used. Use of versions that are no longer supported, and failure to apply the latest updates may increase your exposure to cyber threats.

Traxon strongly recommends to comply with security advisories on the latest security threats, patches and other related measures.

4 Connectors and interfaces

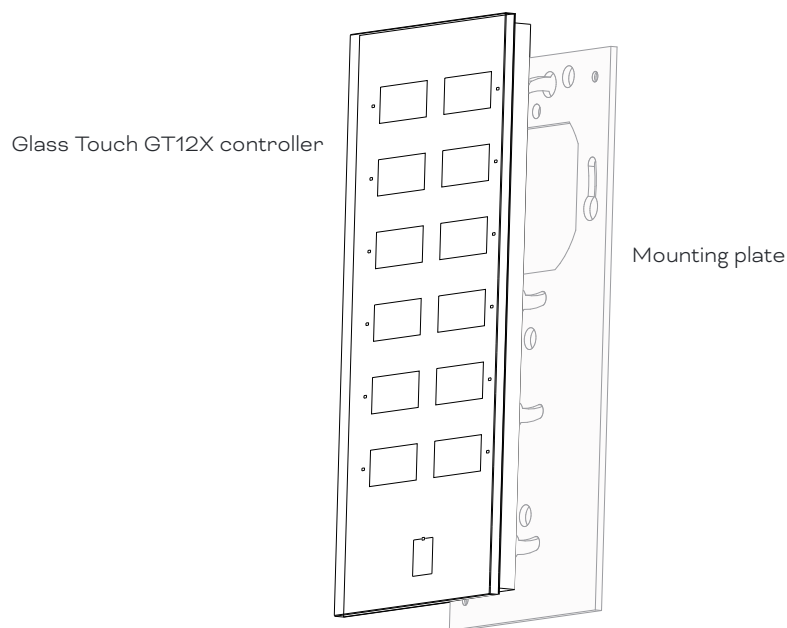

4.1 User interfaces

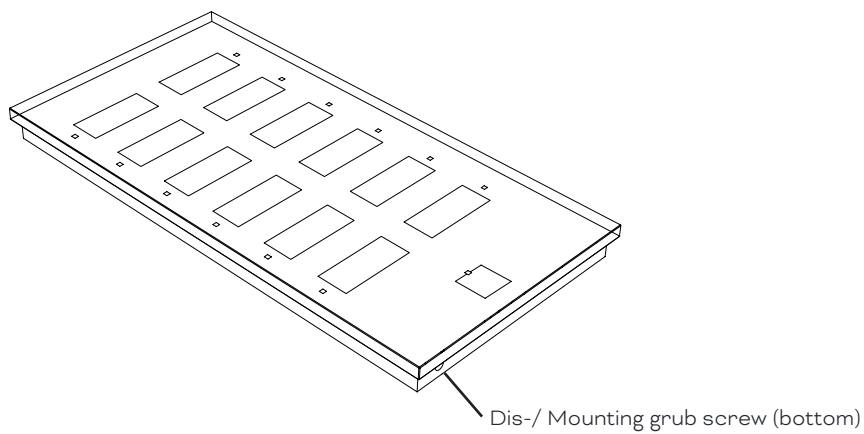
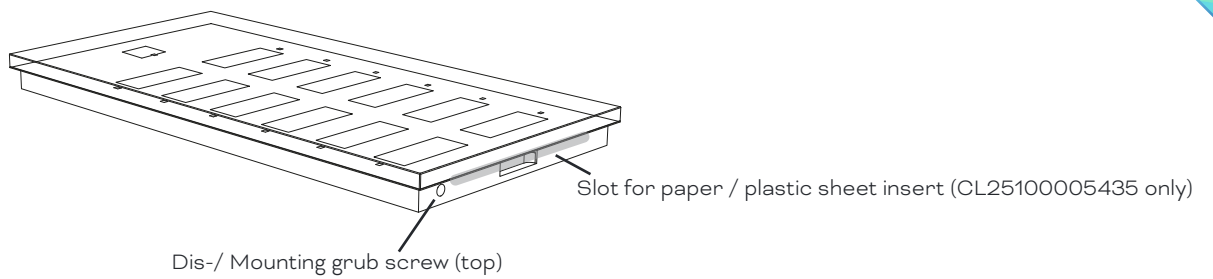
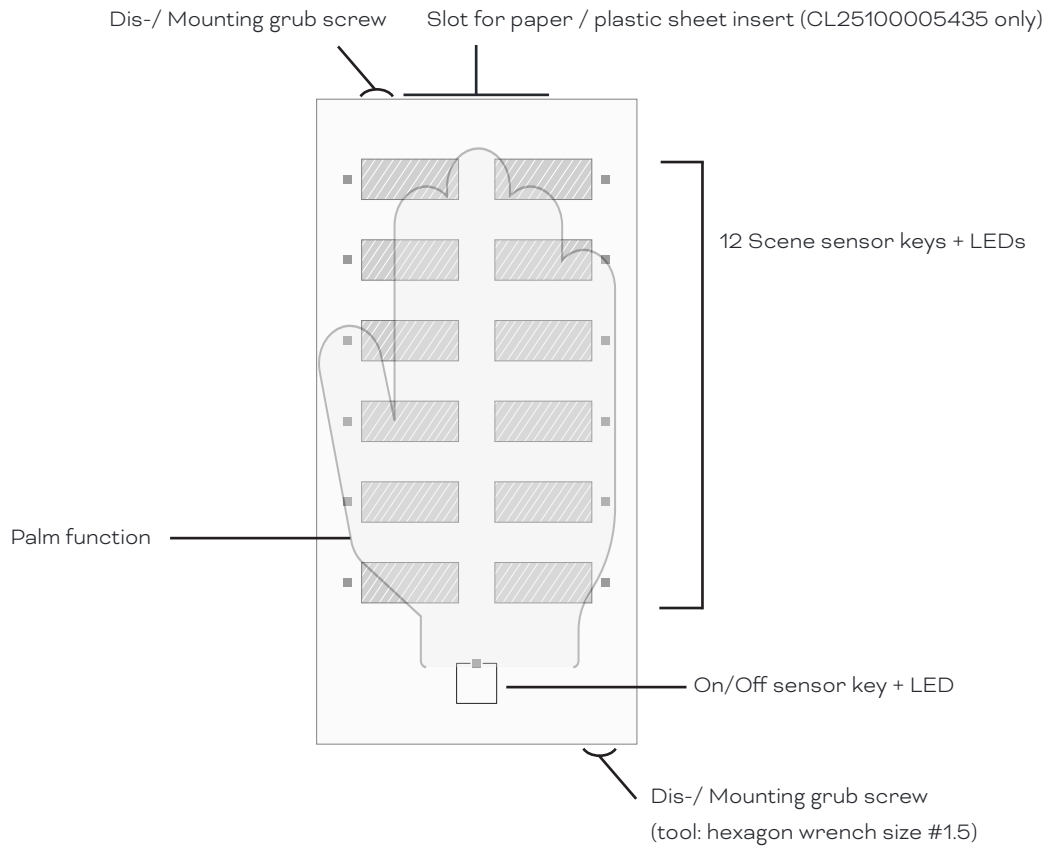

4.2 Connections

Rear view:

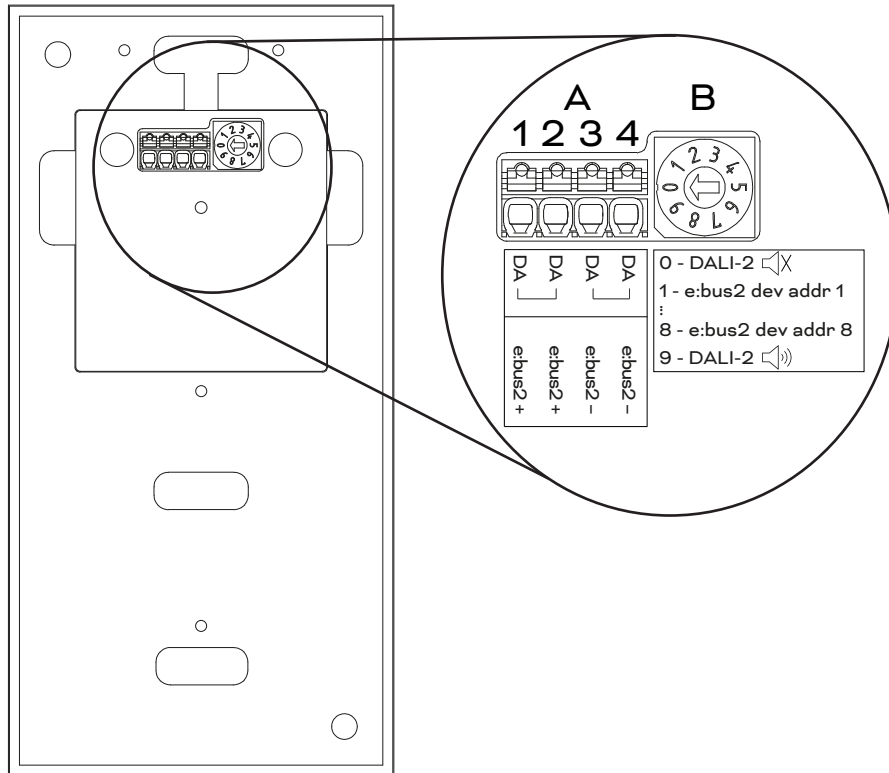

A Data wires

- | | |
|---|-------------------------------|
| 1 | DA
e:bus2 (for Butler XT3) |
| 2 | DA
e:bus2 (for Butler XT3) |
| 3 | DA
e:bus2(for Butler XT3) |
| 4 | DA
e:bus2(for Butler XT3) |

B Rotary DIP switch

see [“5 DIP switch: Protocol Selection & Addressing”](#) (page 10)

5 DIP switch: Protocol Selection & Addressing

The rotary DIP switch defines the protocol selection and, where applicable, device address.

For the DIP switch settings to take effect, the Glass Touch GT12X must be restarted: power cycle the device if it was already in operation.

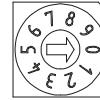

Rotary DIP switch	Description
0	DALI-2 protocol with feedback tone on sensor key press.
1 ... 8	e:bus2 protocol device address. Every device (max. 8) needs a unique address. For Butler XT3 connection. Feedback tone needs to be enabled via LAS Programmer.
9	DALI-2 protocol without feedback tone.

6 Wiring System

e:bus2:

Wiring example: (Butler XT3)

A) e:bus2 (2-wire cabling - tentative: up to 300m)

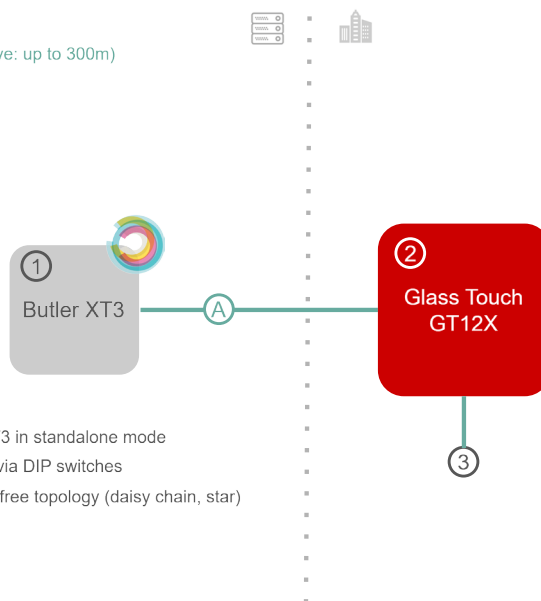

- 1) Software, running on Butler XT3 in standalone mode
- 2) manual address configuration via DIP switches
- 3) up to 8 x Glass Touch GT12X, free topology (daisy chain, star)



DALI-2

Wiring example: (Fusion)

A) DALI-2 (2-wire cabling - up to 300m)

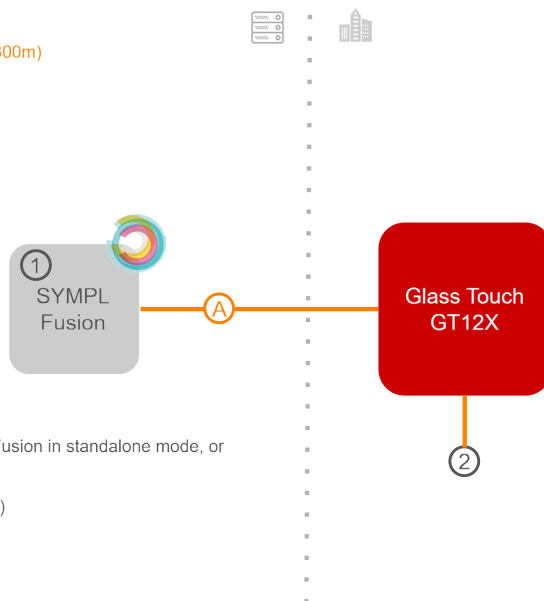

- 1) Software, running on SYMPL Fusion in standalone mode, or 3rd party DALI controller
- 2) free topology (daisy chain, star)

Please check DALI specification for cable types and requirements.

Glass Touch GT12X installations, whether using DALI-2 or e:bus2, can be arranged in any topology if the following cable requirements are met.

Depending on the power source (using DALI-2 e.g. the SYMPL Fusion DALI module; or using e:bus2 the Butler XT3), the cross-section and material of the wire, and the maximum operating temperature, the **maximum cable length between any two devices on the bus** (including any bus units and bus power supplies) must not exceed the values in the following tables.

DALI-2	Cable type	Cable cross section in mm ²	Maximum cable length in m	
			25 °C	45 °C
Supply current 250 mA	Aluminum	0.25	38	34
		0.5	75	68
		0.75	113	103
		1.0	151	137
		1.5	226	205

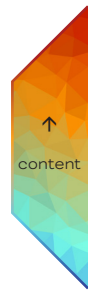

		Cable type	Cable cross section in mm ²	Maximum cable length in m	
				25 °C	45 °C
e:bus2	Copper	0.25	56	51	
		0.5	112	102	
		0.75	169	153	
		1.0	225	204	
		1.5	300*	300*	
		Supply current 130 mA	Aluminum	0.25	73
		0.5	145	132	
		0.75	218	197	
		1.0	290	263	
		1.5	300*	300*	
	Copper	0.25	108	98	
		0.5	216	196	
		0.75	300*	294	
		1.0	300*	300*	
		1.5	300*	300*	

* It is not recommended to exceed 300 meters.



Interacting with multiple Glass Touch GT12Xs on the same bus at the same time may cause delayed or omitted messages.

7 Power supply

The Glass Touch GT12X is powered via the data bus wires: either via e:bus2 or via DALI-2.



- Do not install the Glass Touch GT12X to a powered DALI bus.
- It is recommended not to install the Glass Touch GT12X to a powered e:bus2 bus.

8 Paper / plastic sheet insert

With the Glass Touch GT12X CL25200008035 the description of the 12 sensor keys (not the On/Off sensor key) is customizable. You can use the provided insert or create custom inserts.



The sensor keys may not work properly without paper / plastic sheet insert.

How to create and use custom inserts:

1. Design a paper / plastic sheet insert in accordance to the intended configuration of the sensor keys („10 Configuration“ on [page 17](#)). Click [here](#) or scan the QR code to go to the Glass Touch Designer and create your personalized insert.
2. Print in actual size (59.75 x 136.36 mm) and cut it into shape. Use the cutting lines for guidance.

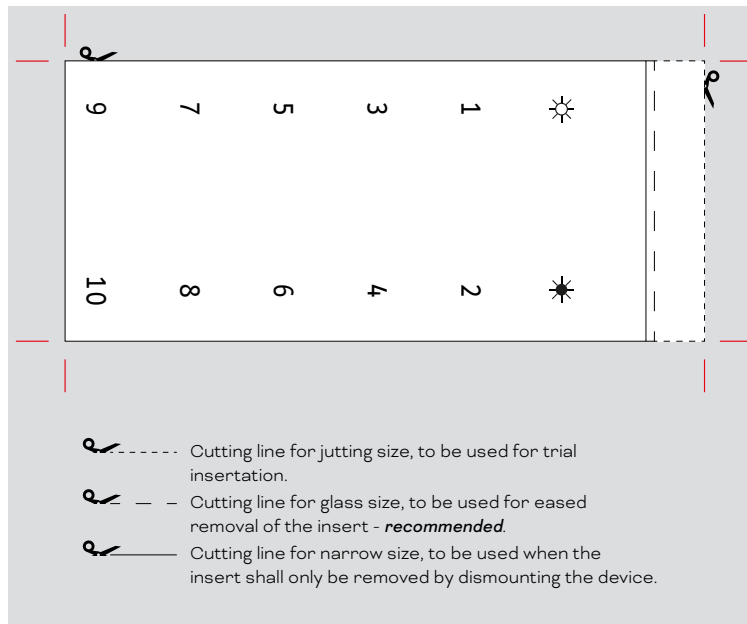

It is recommended to first use the jutting size for trial insertion.

For the final size, it is recommended to use the glass size. To ease removal, bend the upper strip at the solid line backwards.

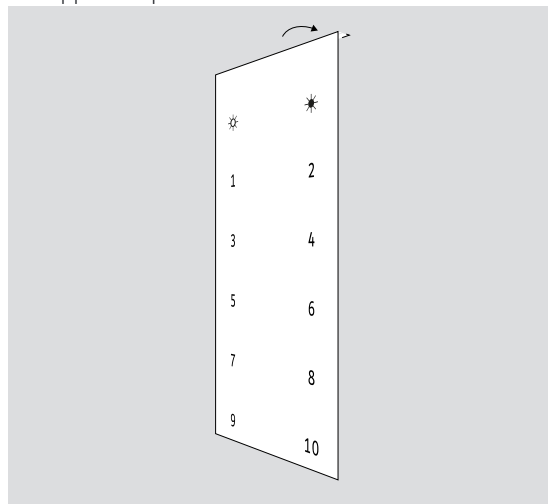

3. Insert the paper / plastic sheet from the top slot into the Glass Touch GT12X.

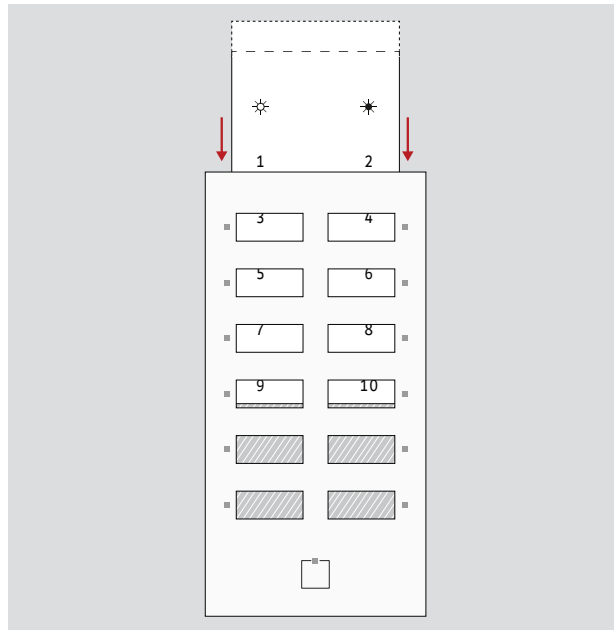

To remove the insert:

- When cut to jutting size and glass size: Grab the top edge of the paper / plastic sheet insert and pull the insert out.

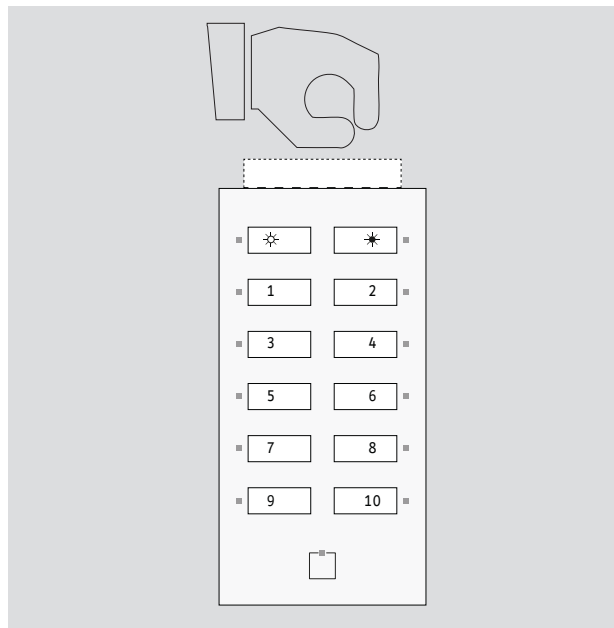

- When cut to narrow size: Dismount the device from the mounting plate (and disconnect cables if they do not allow enough space) and gently shake the Glass Touch GT12X for the insert to emerge.

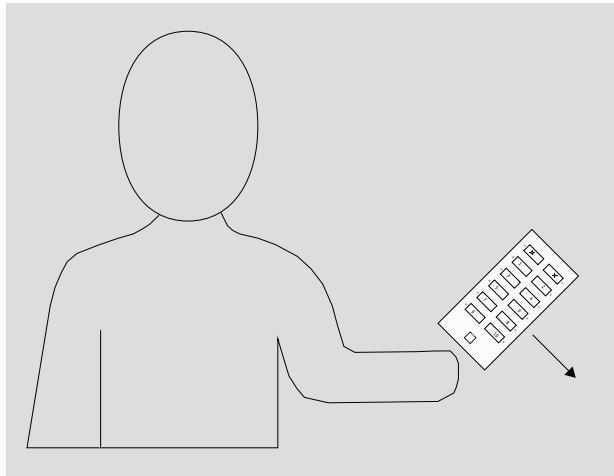

Do not use metal or other hard tools to remove the insert. This could damage the glass print.

For additional insert plastic sheet sheets, please use tear-resistant, water-repellent and seawater-resistant foil, e.g. Xerox Premium Never Tear 003R98092.

9 Mounting

The Glass Touch GT12X can be mounted in most standard in-wall mounted boxes (EU, US, UK, JP etc.). It is recommended to install it in a double-box to have more room for the cabling. Mount the device after all connections are done.

1. Mount the mounting plate for the Glass Touch GT12X with screws on the in-wall mounted boxes, recess to the top. Use a spirit level to ensure proper positioning. Use as many of the appropriate fixing holes of the mounting plate as possible., but at least 2.

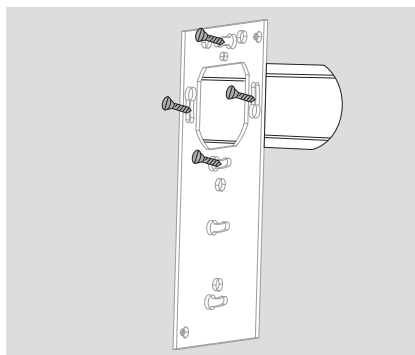

2. Set the rotary DIP switch and make all required connections to the Glass Touch GT12X.



3. Place the Glass Touch GT12X on the mounting plate.

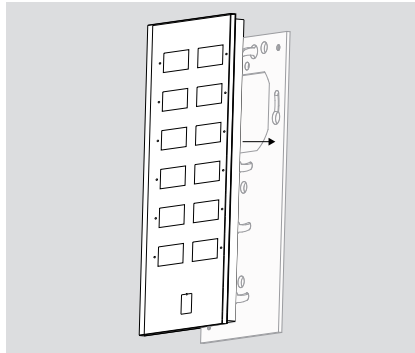

4. Lock it with the two grub screws at the top and bottom of the Glass Touch GT12X with the provided hexagon wrench (hex wrench size #1.5).

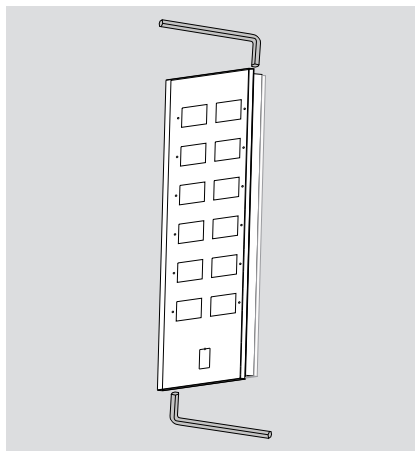

- Glass surface. Handle with care to avoid breakage or injuries.
- Do not install in locations where collision is likely.
- Replace the device if the glass surface is cracked or damaged.
- To avoid interference, such as from cables in the in-wall box, the Glass Touch GT12X must be mounted with/on the backplate.
- Do not over-tighten the mounting screws for the mounting plate. This may damage the holes for the screws or the mounting plate gets twisted.
- If the mounting plate does not fit flush against the back of the Glass Touch GT12X, you can carefully bend the mounting plate slightly by hand.



10 Configuration

The configuration of the sensor key presses and the tone depends on the configured protocol type and DIP switch position (see „5 DIP switch: Protocol Selection & Addressing“ on page 10):

- DALI-2 → in the Sympholight software (see „10.1 DALI-2 in Sympholight“ on page 17).
- e:bus2 → in the LAS software (Lighting Application Suite) (see „10.2 e:bus2 in LAS“ on page 19). The tone is only available when the device is connected to the LAS, not when unconnected.

10.1 DALI-2 in Sympholight

Add the device to your project and configure its Workflow block in the Workflow Designer of the Automation tab.

1. Set the rotary DIP switch to 0 or 9 (see „5 DIP switch: Protocol Selection & Addressing“ on page 10).
2. Connect the Glass Touch GT12X to a DALI module of a SYMPL Fusion or to a SYMPL dali Node.
3. Connect the SYMPL Fusion or SYMPL dali Node to your installation and into the project's network.
4. Open the Sympholight software.
5. Make sure Sympholight runs on full version (license is present).
6. When using a SYMPL Fusion, in the **Setup tab - Sympholights**, right-click on the SYMPL Fusion and **redirect the module of the Fusion to your local instance**.

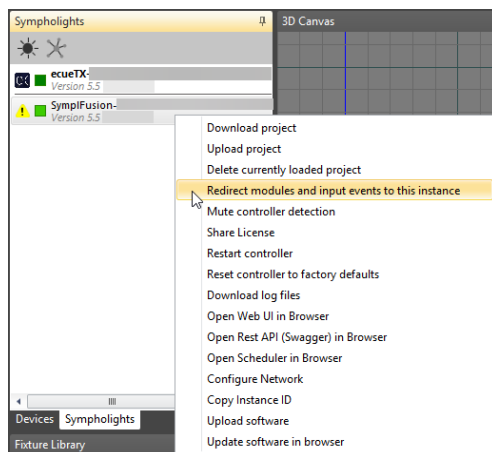

7. In the **Setup tab - Devices**, open the **Device Manager** and add the DALI module or the SYMPL dali Node to your project.

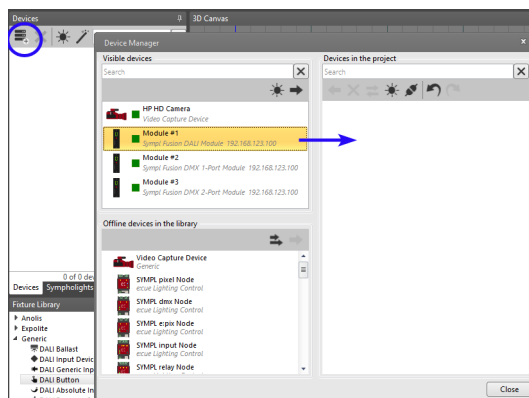

- At **Layout - DALI Lines** select the DALI line of the module or node and make sure at its **Properties**, that the **Input Type** is set to **"DALI 2"**.

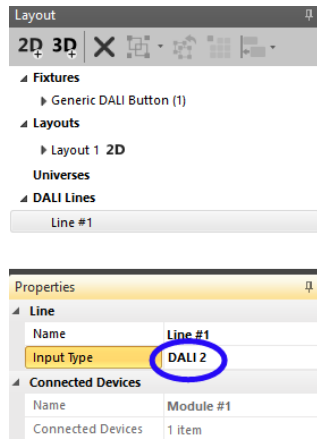

- At the **DALI window - Real Devices** select the DALI line and scan it. The Glass Touch GT12X will be listed with one Input device and 14 buttons.

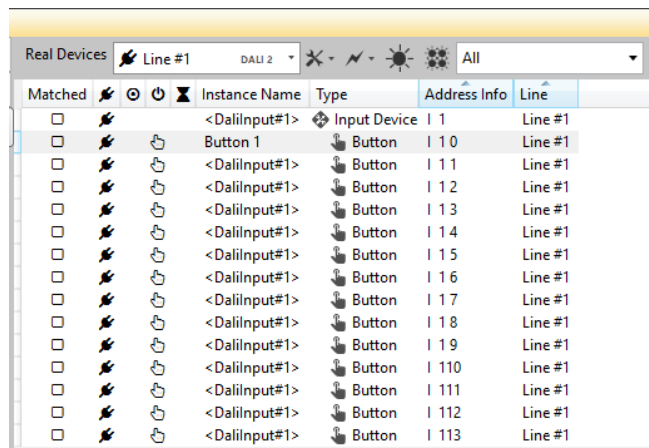

The instance numbers for the buttons are as follows:

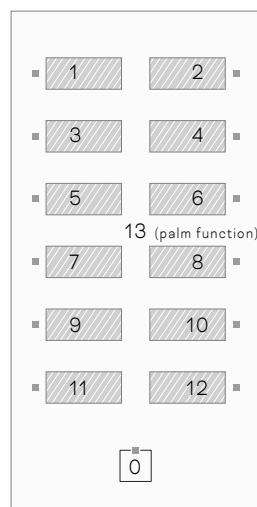

- Drag and drop the real input devices onto the canvas -> matching virtual devices will be created.
- Configure the properties of the instances at **Virtual Devices - Properties**.

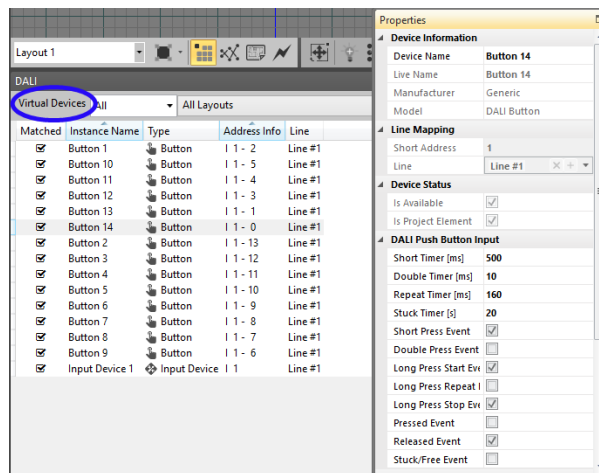

Adjust timings for long and short press to your desired reaction time.



The palm function (instance #13) is preconfigured in the device and directly outputs a short press, i.e. only supports Short Push, Switch On and Switch Off events.

12. Complete your project programming, e.g. at [Automation - Workflow Designer](#) integrate the DALI Button blocks and the DALI Button Line block into your workflow.
13. To utilize the DALI LED feedback options, use the feedback function of the DALI Button blocks and the DALI Feedback Channel Line block.

10.2 e:bus2 in LAS

1. Set the rotary DIP switch to 1... 8 (see „5 DIP switch: Protocol Selection & Addressing“ on page 10).
2. Connect the Glass Touch GT12X to a Butler XT3.
3. Connect the Butler XT3 to your installation and into the project’s network.
4. Open the LAS software.
5. To add the Butler XT3 to the Programmer configuration start the Device Manager.

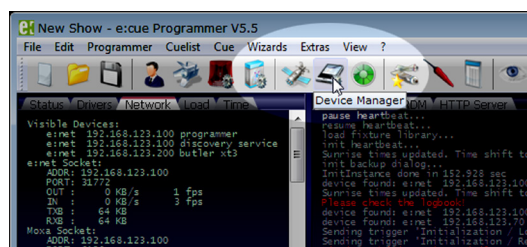

6. Execute the Automatic Setup Wizard. The Butler XT3 will be found and displayed:

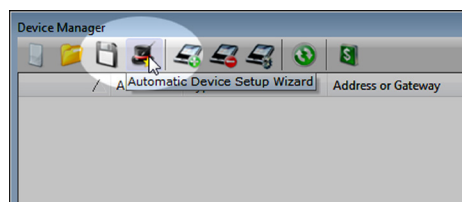

7. Set the checkmark for the Butler XT3 to add it to your setup or click the Select button. Enable *Continue with scan for Glass Touch devices* to discover the Glass Touches connected via e:bus2 to the Butler XT3.



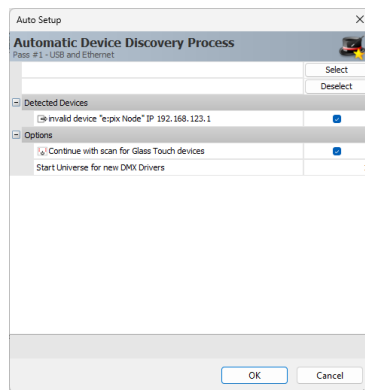

8. Click **OK** to add the Butler XT3 to the Programmer configuration, the Butler XT3 and the Glass Touch(es) are now available.
9. To enable the feedback tone, open the Device Properties of the Glass Touch and enable the **Keyboard Beep**.

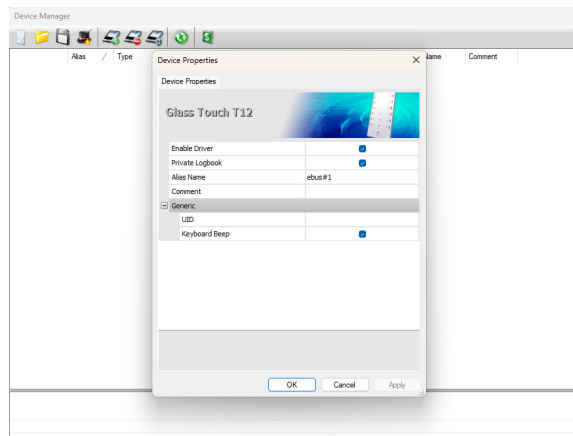

10. Complete your project programming.

11 Cleaning

For cleaning the surface, the Glass Touch GT12X provides the so-called cleaning mode. During the cleaning mode, any touch presses on the device are unregistered and do not cause any command. The LEDs will be updated on external control commands nonetheless and always show the current status of the configured setup.

1. To start the cleaning mode, press the palm of your hand onto the surface of the Glass Touch GT12X until a short beep sequence is played. Short press triggers that might be configured in the workflow will not be fired.
2. Now the cleaning mode is active - start cleaning.



- Clean with a soft cloth and non-abrasive cleaners to avoid scratching the glass surface.
- Do not use wet cloths or excessive amounts of liquid. This could damage the paper / plastic sheet insert (CL25100005435 only).

3. When the device registers no touch activities on the surface for ~5 seconds, another beep sequence announces the deactivation/ stop of the cleaning mode. The device will be back in default operation mode.

12 Dismounting

1. Release the two grub screws at the top and bottom of the Glass Touch GT12X with the provided hexagon wrench (hex wrench size #1.5) to unlock the Glass Touch GT12X.

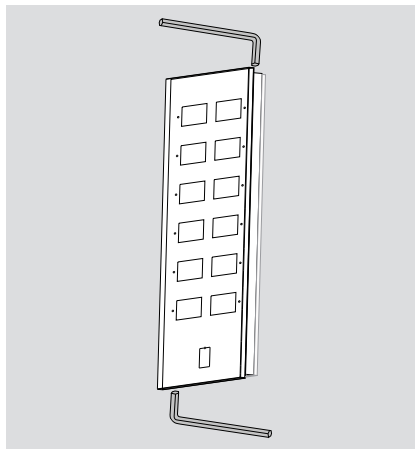

2. Unhinge the Glass Touch GT12X from the mounting plate (move vertically away from mounting plate).

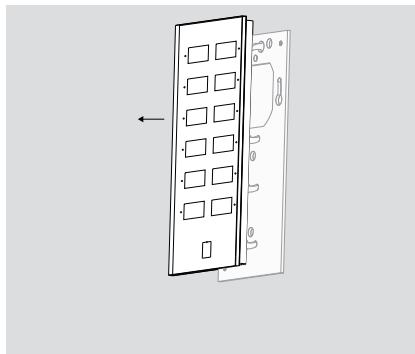

3. Disconnect all cables.



13 Certifications



Conforms to ANSI/UL Std. 62368-1
Certified to CSA Std. C22.2 NO. 62368-1



14 Dimensions

All dimensions in mm

Glass Touch GT12X controller:

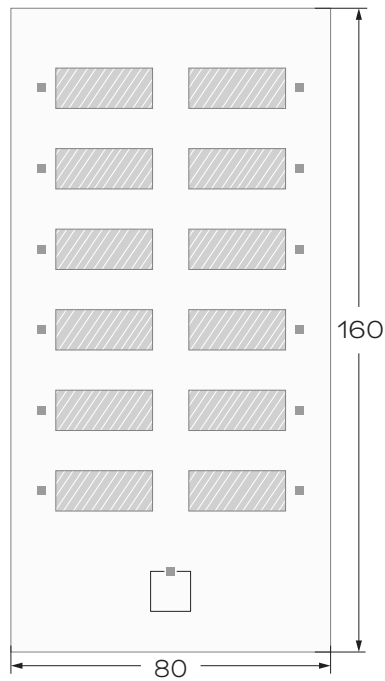

Mounting Plate:

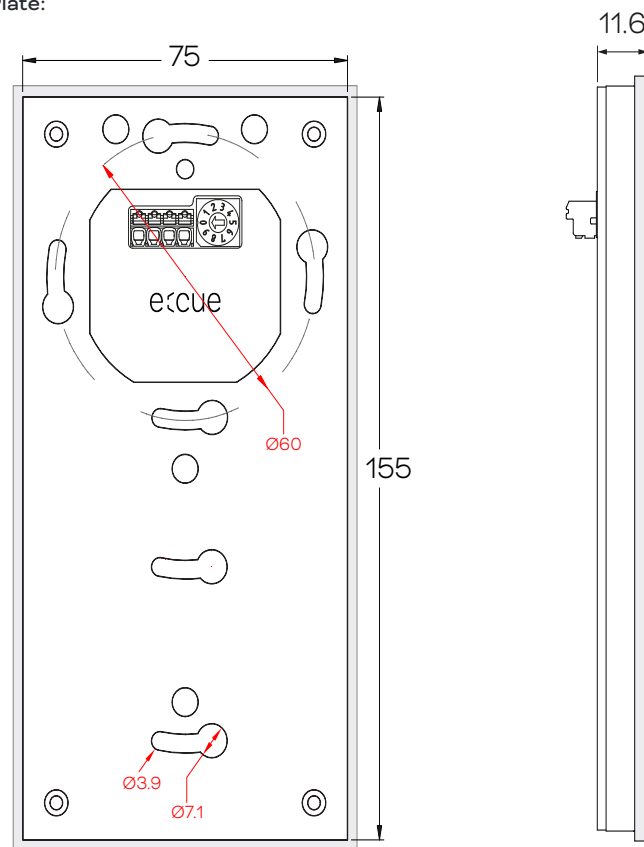

15 Troubleshooting

No function of the device.

Check the connection of the data cables and the power supply of the hosting e:bus2 or DALI-2 bus device (e.g. e:cue Butler XT3 or SYMPL Fusion). Check that the correct protocol is configured via the rotary DIP switch on the backside („5 DIP switch: Protocol Selection & Addressing“ on page 10). When using e:bus2, check that each Glass Touch GT12X has a unique address configured via the rotary DIP switch.

Device starts up, but hangs and has no function.

Contact the e:cue support.

The feedback tone does not work.

Check if using the feedback tone is allowed with the rotary DIP switch set to number 0 (zero) on the backside („5 DIP switch: Protocol Selection & Addressing“ on page 10) or check whether enabled in LAS.

Can I repair the device myself?

No. Do not try to repair the device. Return it to your e:cue distributor for replacement or repair.

16 FAQ

Is it possible to use more than one Glass Touch GT12X?

Yes. You can integrate multiple Glass Touch GT12Xs in your installation. Using e:bus2 you can connect up to 8 devices. Using DALI-2, the amount is limited by the values of the DALI-2 standard. Make sure that each device has a unique address.

How can I supply power to the Glass Touch GT12X?

The Glass Touch GT12X is powered via the data bus wires: either via e:bus2 or via DALI-2 („4.2 Connections“ on page 09).

How can I set the protocol type?

The Glass Touch GT12X supports the e:bus2 and DALI-2 protocols. Set the protocol via the rotary DIP switch on the backside („5 DIP switch: Protocol Selection & Addressing“ on page 10).

Can I combine the Glass Touch GT12X with e:bus devices?

No, the e:bus2 protocol is not compatible with the e:bus protocol. Therefore do not mix the Butler XT2 or the previous Glass Touch devices with the Glass Touch GT12X. Only use the Butler XT3 and Glass Touches of the X version together with the Glass Touch GT12X.

