

Project: _____
 Type: _____



ProPoint Vista 1x100W RGBW

The ProPoint Vista RGBW is an AC line powered, high brightness luminaire. Controllable with DMX512, the ProPoint Vista 100W RGBW is a new member of the Vista family, along with the 200W and 400W. The daisy chain topology, and direct-wire nature of the fixture via the two integral cable whips allow for simple installation into existing installations and new structures, and is ideal for high-rise and tower illumination. This product is intended for use in high-quality colored light applications.



Product Specifications

Model	ProPoint Vista 1x100W RGBW	
Light Source	Discrete LED x 42	
Color Range	RGBW (White CCT: 4000K standard) Other White CCT and RGBA available ¹	
Beam Angle	3° native; 5°, 8°, 10°, 15°, 20°, 30°, 40°, 55°, 80°, 50° x10°, 50° x5° via accessory Internal Louver (Standard)	
Luminous Flux	6012 lm	
Efficacy	57 lm/W	
Lumen Maintenance	L70 @25°C 81,000hrs	
Cover Lens	Tempered Glass	
Housing	Die Cast Aluminum	
Housing Finish Options	Gray (RAL7015), Black (RAL9005), White (RAL9003)	
Adjustment Options	±90° Vertical	
Dimensions (W x H x D)	649mm x 286.8mm x 144mm / 25.6" x 11.3" x 5.7"	
Weight	14.5kg / 31.96lbs.	
EPA (sq.ft)	ProPoint Vista 1x100W: Front: 1.02 Side: 0.42	ProPoint Vista 1x100W with Pole mount: Front: 1.3296 Side: 0.6576
Regulatory Listing & Safety Approval	cETLus, CE, FCC, RoHS, REACH, ASTM B117-16, ANSI 3G, IK08	
Operating Temperature	-30°C to +55°C / -22°F to +131°F	
Minimum Starting Temperature	-20°C / -4°F	
Storage Temperature	-40°C to +80°C / -40°F to +176°F	
Environment	Outdoor (IP66), suitable for coastal environments	
Humidity	85%, non-condensing	

Electrical Specifications

Input Voltage²	120-277V ac 50/60Hz
Power Consumption	100W
Power Factor	≥ 0.9

System Specifications

Technology	DynaMood®: BeamOne
Control	DMX512, RDM Enabled
Addressing Options	Address set via RDM
Power	AC Line
Power Supply	Integrated

1. No MOQ required. Please consult regional sales office for pricing and lead time.
 2. Auto-switching. Single phase (line, neutral and ground).

LED CHARACTERISTICS Because LEDs are semiconductor devices, their performances are subject to inherent variability commonly found in semiconductor industry. To improve consistency in performance across the same product, LED manufacturers "sort" LEDs into bins according to different preset parameters, such as forward driving voltage, illumination, etc. Whereas binning is a sorting function, it is not a correction process. Inherent variability in the manufacturing process results always in different binning distributions according to different production lots. Traxon uses automatically binned LEDs on its products, thereby minimizing output variations within the model range.

As with all electronic devices, LED output degrades over time – a term called lumen depreciation. This also explains why it is nearly impossible to expect photometric performances of two LED products with different service life spans to be the same. The rate of LED degrade is a complicate function of many factors such as operating efficiency, duration of continuous operation, and more significantly, environmental conditions (ambient temperature for example). If allowed working under optimal operating temperature range and with good ventilation, LED devices enjoy long service lives over conventional light sources. When using/installing LED devices, care should be taken to ensure that the devices will operate within the operating conditions specified in respective product literature.

This product contains a light source of energy efficiency class G to Regulation (EU) No 2019/2015. Lumen measurement complies with LM-79-08 standard. Lumen maintenance is calculated based on LM-80 compliant measurement.

Source Specifications

Optics 3°

Candela Distribution

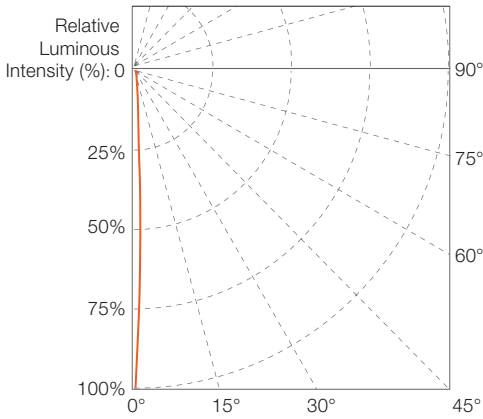

Light Output

Color	Luminous Flux (lm)	Center Intensity (cd)	Efficacy (lm/W)
RGBW FULL ON	6012	561827	57
Red ON	574	55745	38
Green ON	1752	168702	53
Blue ON	294	25901	16
White ON	3568	319464	64

Illuminance at a Distance

	Center beam Lux/klm	Beam width (m) H
10m	929	0.66m
20m	232	1.33m
30m	103	1.99m
40m	58	2.65m
50m	37	3.32m
60m	26	3.98m
70m	19	4.64m

● Horiz. Spread: 3.8°

For fc divide by 10.7

For feet multiply by 3.28

IES and LDT files are available for download from the Traxon website.

Fixture

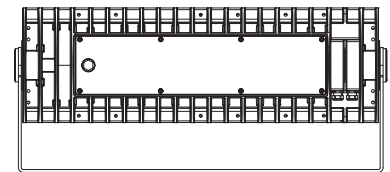
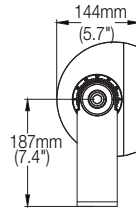
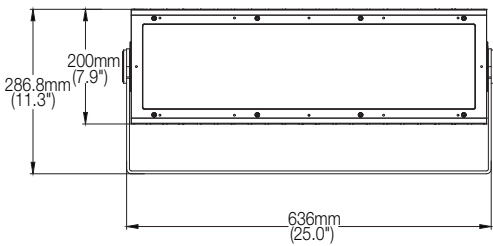
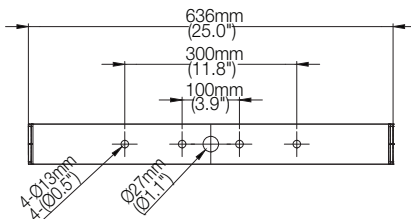
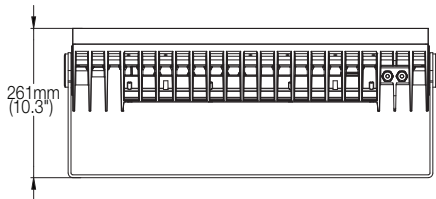
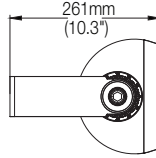
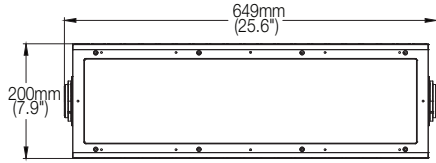

ProPoint Vista 100W open wire cable lengths

	Power input cable	Data in/out cable (combined)
Cable Length (open wire)	1830mm (72")	1830mm (72")
Cable Outer Diameter	7.8mm (0.31")	8.1mm (0.32")

Full Glare Shield

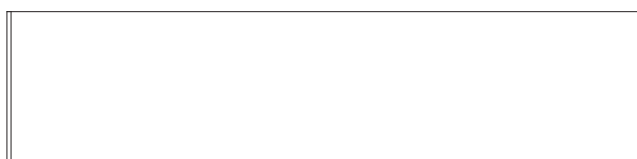
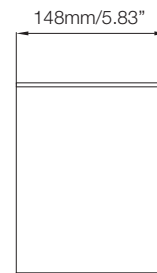
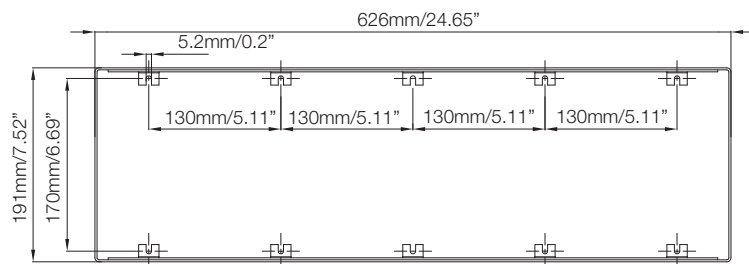

ProPoint Vista 1x100W RGBW

Dimensions

Half Glare Shield

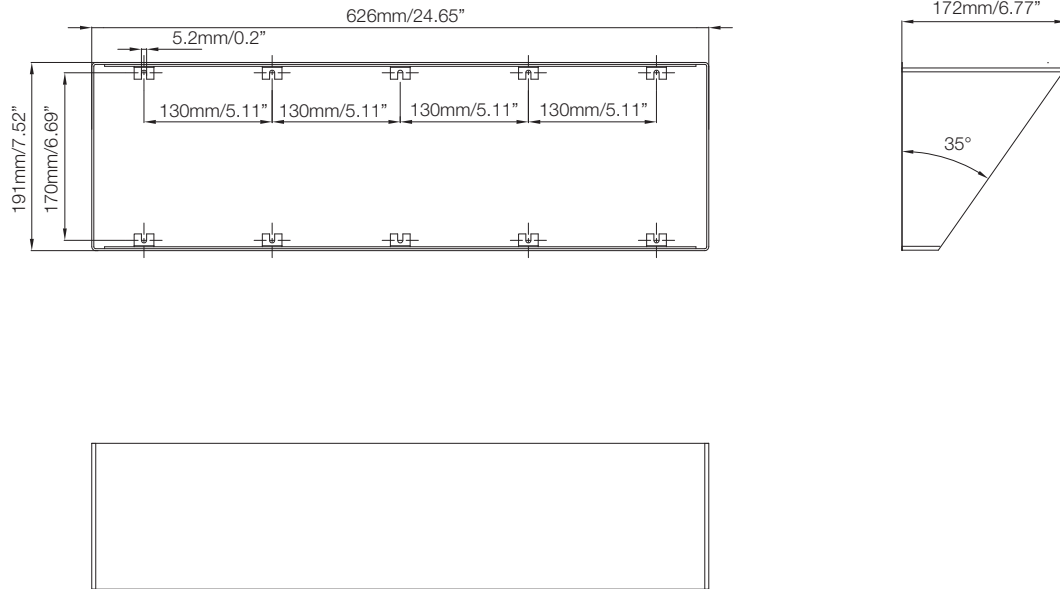

Pole-Mounting Supporter

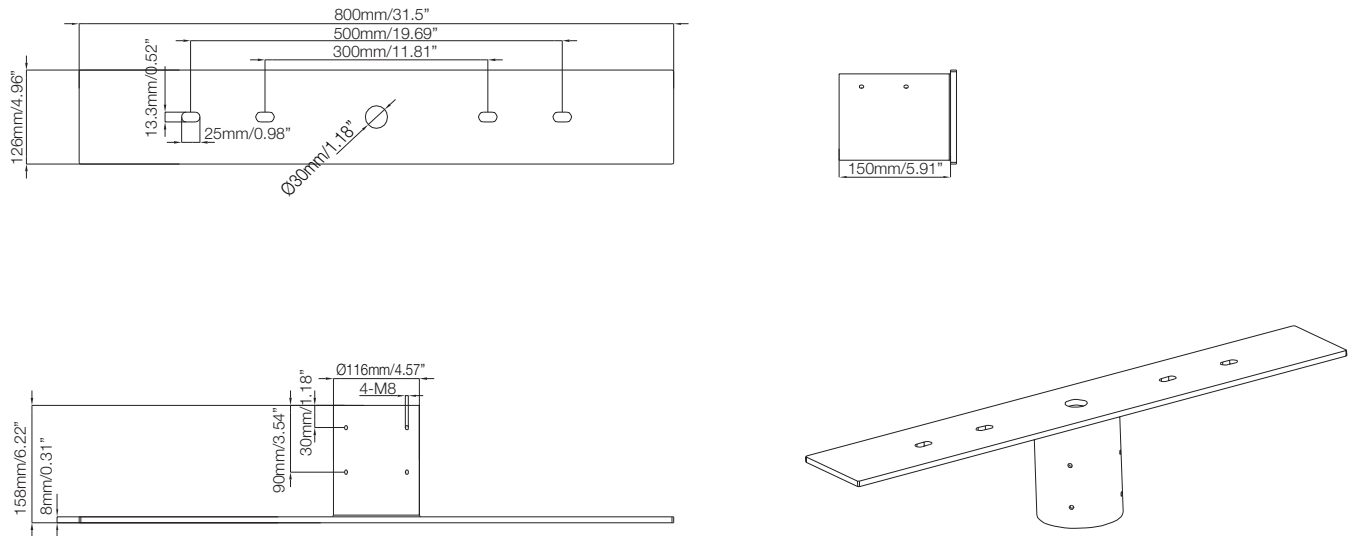

Rock Guard

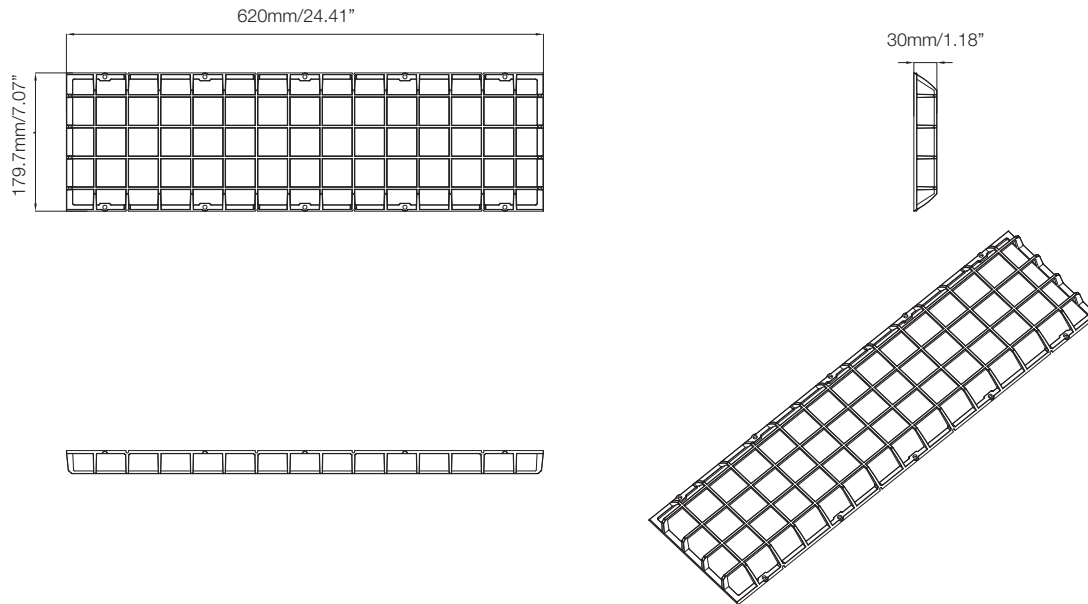

Spread Lens Frame

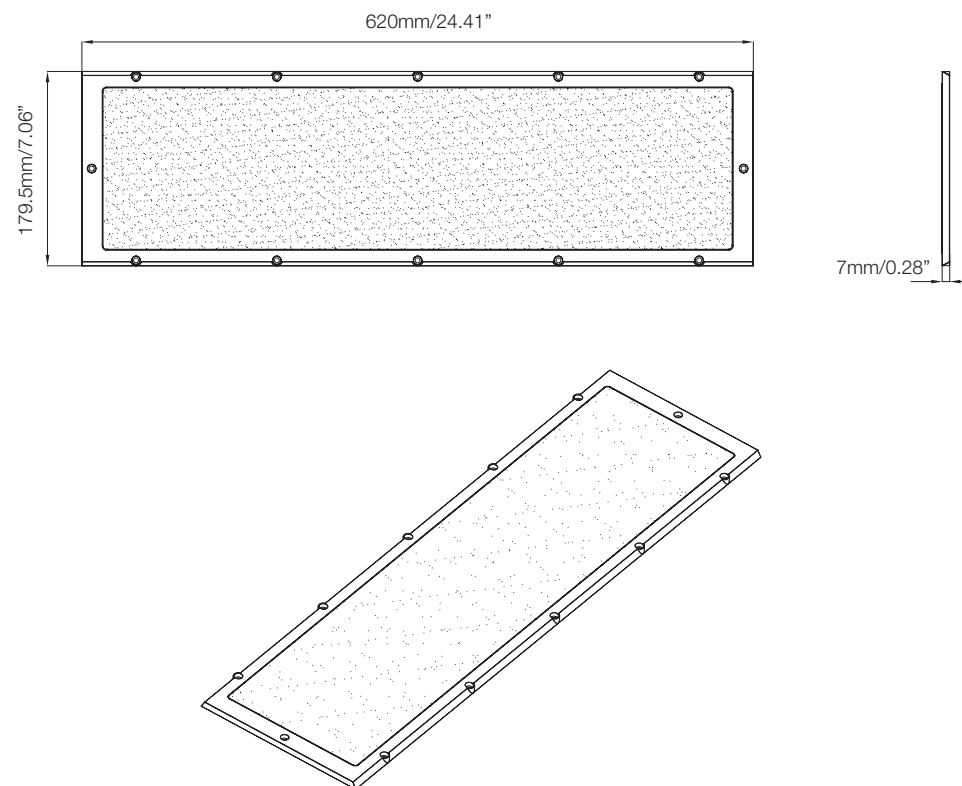

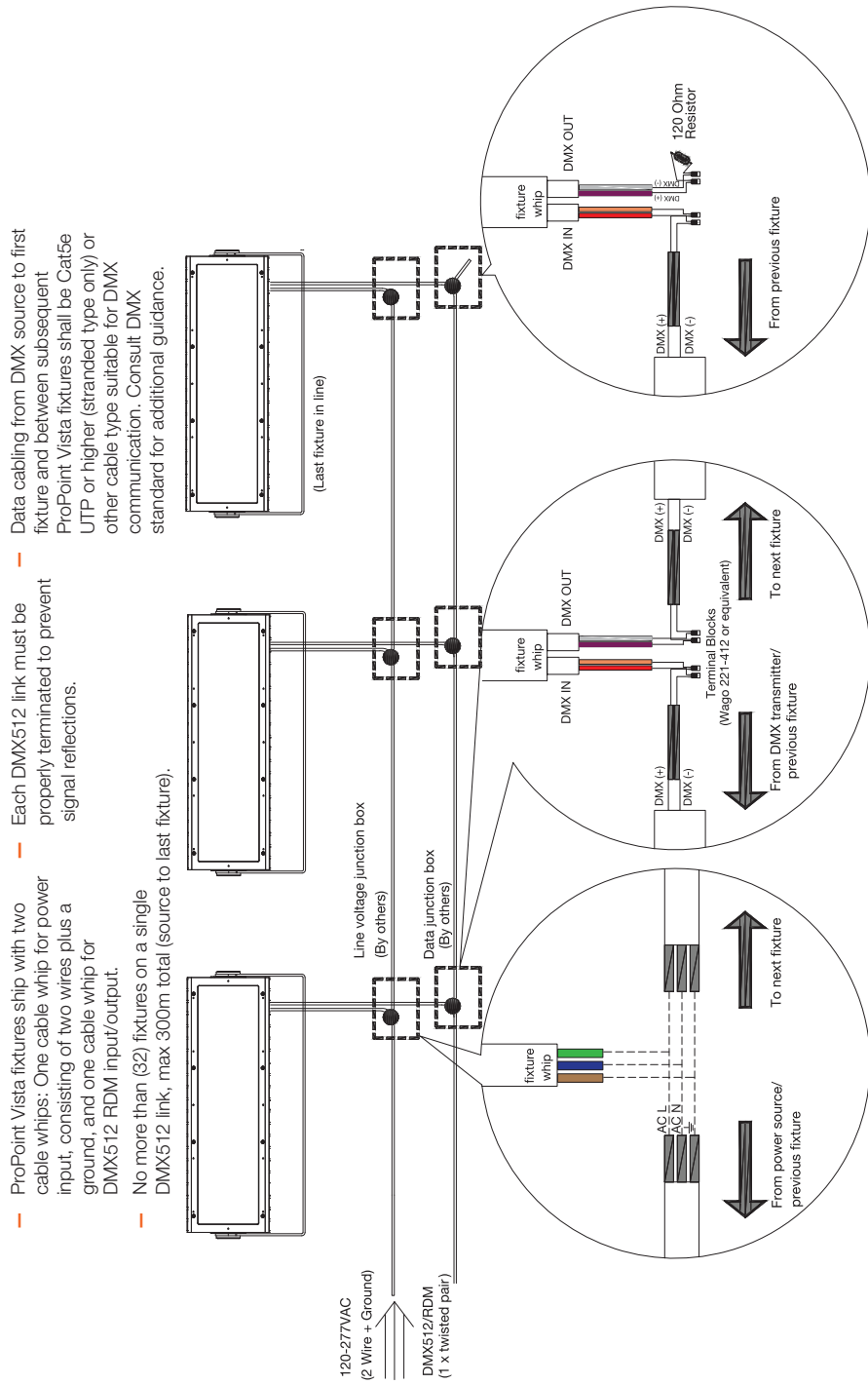

- ProPoint Vista fixtures ship with two cable whips: One cable whip for power input, consisting of two wires plus a ground, and one cable whip for DMX512 RDM input/output.
- No more than (32) fixtures on a single DMX512 link, max 300m total (source to last fixture).
- Each DMX512 link must be properly terminated to prevent signal reflections.
- Data cabling from DMX source to first fixture and between subsequent ProPoint Vista fixtures shall be Cat5e UTP or higher (stranded type only) or other cable type suitable for DMX communication. Consult DMX standard for additional guidance.

General Notes

- All data cabling must adhere to ANSI E1.11-2008 (R2013) – Entertainment Technology – USITT DMX512-A, Asynchronous Serial Digital Data Transmission Standard for Controlling Lighting Equipment and Accessories.
- Fixture is RDM compatible.
- Fixtures allow a universal input of 120VAC to 277VAC.
- Data termination shall utilize cage clamp terminal blocks, or equivalent. Wire nuts are not permissible and will void warranty.
- The method of line voltage termination, both for data and power, is at the discretion of the installing contractor, and/or engineer.
- Cables must be spliced/joined in a weatherproof enclosure/junction box, which is to be properly rated and provided by others.

ProPoint Vista 1x100W RGBW

Ordering

Model Number

PP	.	V5	.	9	.	4	.	4	.	1	.	1	.	X
ProPoint		Vista		Control		Color		CCT		Optic		Finish		
		V5: 100W x 1		9: DMX		4: RGBW		4: 4000K		1: 3°		1: Gray		
												2: Black		
												3: White		

Fixtures

Model No.	Description	Item Code
PP.V5.944111	PROPOINT VISTA 1x100W RGBW 3°	AM410120055
PP.V5.944112	PROPOINT VISTA 1x100W RGBW 3° BL	AM410130055
PP.V5.944113	PROPOINT VISTA 1x100W RGBW 3° WT	AM410140055

Accessories

Model No.	Description	Item Code
PP.VA.510001	PROPOINT VISTA 100W ANTI-GLARE HALF SHIELD	AM410300055
PP.VA.520001	PROPOINT VISTA 100W ANTI-GLARE FULL SHIELD	AM410310055
PP.VA.530001	PROPOINT VISTA 100W ANTI-GLARE MASK - ROCK GUARD	AM410320055
PP.VA.541001	PROPOINT VISTA 100W SPREAD LENS MODULE - 5°	AM410330055
PP.VA.542001	PROPOINT VISTA 100W SPREAD LENS MODULE - 8°	AM410340055
PP.VA.543001	PROPOINT VISTA 100W SPREAD LENS MODULE - 10°	AM410350055
PP.VA.544001	PROPOINT VISTA 100W SPREAD LENS MODULE - 15°	AM410360055
PP.VA.545001	PROPOINT VISTA 100W SPREAD LENS MODULE - 20°	AM410370055
PP.VA.546001	PROPOINT VISTA 100W SPREAD LENS MODULE - 30°	AM410380055
PP.VA.547001	PROPOINT VISTA 100W SPREAD LENS MODULE - 40°	AM410390055
PP.VA.548001	PROPOINT VISTA 100W SPREAD LENS MODULE - 55°	AM410400055
PP.VA.549001	PROPOINT VISTA 100W SPREAD LENS MODULE - 80°	AM410410055
PP.VA.54A001	PROPOINT VISTA 100W SPREAD LENS MODULE - 50° x 10°	AM410420055
PP.VA.54B001	PROPOINT VISTA 100W SPREAD LENS MODULE - 50° x 5°	AM410430055
PP.VA.541002	PROPOINT VISTA 100W SPREAD LENS MODULE - 5° BL	AM410470055
PP.VA.542002	PROPOINT VISTA 100W SPREAD LENS MODULE - 8° BL	AM410480055
PP.VA.543002	PROPOINT VISTA 100W SPREAD LENS MODULE - 10° BL	AM410490055
PP.VA.544002	PROPOINT VISTA 100W SPREAD LENS MODULE - 15° BL	AM410500055
PP.VA.545002	PROPOINT VISTA 100W SPREAD LENS MODULE - 20° BL	AM410510055
PP.VA.546002	PROPOINT VISTA 100W SPREAD LENS MODULE - 30° BL	AM410520055
PP.VA.547002	PROPOINT VISTA 100W SPREAD LENS MODULE - 40° BL	AM410530055
PP.VA.548002	PROPOINT VISTA 100W SPREAD LENS MODULE - 55° BL	AM410540055
PP.VA.549002	PROPOINT VISTA 100W SPREAD LENS MODULE - 80° BL	AM410550055
PP.VA.54A002	PROPOINT VISTA 100W SPREAD LENS MODULE - 50° x 10° BL	AM410560055
PP.VA.54B002	PROPOINT VISTA 100W SPREAD LENS MODULE - 50° x 5° BL	AM410570055
PP.VA.541003	PROPOINT VISTA 100W SPREAD LENS MODULE - 5° WT	AM410610055
PP.VA.542003	PROPOINT VISTA 100W SPREAD LENS MODULE - 8° WT	AM410620055
PP.VA.543003	PROPOINT VISTA 100W SPREAD LENS MODULE - 10° WT	AM410630055
PP.VA.544003	PROPOINT VISTA 100W SPREAD LENS MODULE - 15° WT	AM410640055
PP.VA.545003	PROPOINT VISTA 100W SPREAD LENS MODULE - 20° WT	AM410650055

www.traxontechnologies.com | www.osram.us/traxon

©2022 TRAXON TECHNOLOGIES - AN OSRAM BUSINESS. ALL RIGHTS RESERVED. TRAXON™, TX CONNECT®, ARE TRADEMARKS OF TRAXON TECHNOLOGIES. U.S. PATENTS, E.U. PATENTS, JAPAN PATENTS, OTHER PATENTS PENDING. SPECIFICATIONS ARE SUBJECT TO CHANGE WITHOUT NOTICE.

ProPoint Vista 1x100W RGBW

Ordering

Accessories

Model No.	Description	Item Code
PP.VA.546003	PROPOINT VISTA 100W SPREAD LENS MODULE - 30° WT	AM410660055
PP.VA.547003	PROPOINT VISTA 100W SPREAD LENS MODULE - 40° WT	AM410670055
PP.VA.548003	PROPOINT VISTA 100W SPREAD LENS MODULE - 55° WT	AM410680055
PP.VA.549003	PROPOINT VISTA 100W SPREAD LENS MODULE - 80° WT	AM410690055
PP.VA.54A003	PROPOINT VISTA 100W SPREAD LENS MODULE - 50° x 10° WT	AM410700055
PP.VA.54B003	PROPOINT VISTA 100W SPREAD LENS MODULE - 50° x 5° WT	AM410710055
PP.VA.510002	PROPOINT VISTA 100W ANTI-GLARE HALF SHIELD BL	AM410440055
PP.VA.520002	PROPOINT VISTA 100W ANTI-GLARE FULL SHIELD BL	AM410450055
PP.VA.530002	PROPOINT VISTA 100W ANTI-GLARE MASK - ROCK GUARD BL	AM410460055
PP.VA.510003	PROPOINT VISTA 100W ANTI-GLARE HALF SHIELD WT	AM410580055
PP.VA.520003	PROPOINT VISTA 100W ANTI-GLARE FULL SHIELD WT	AM410590055
PP.VA.530003	PROPOINT VISTA 100W ANTI-GLARE MASK - ROCK GUARD WT	AM410600055
PP.VA.050001	PP VISTA POLE-MOUNTING SUPPORT	AM380750055
PP.VA.050002	PP VISTA POLE-MOUNTING SUPPORT BL	AM380900055
PP.VA.050003	PP VISTA POLE-MOUNTING SUPPORT WT	AM381050055

Our Brands

traxon e:cue

www.traxontechnologies.com | www.osram.us/traxon

©2022 TRAXON TECHNOLOGIES - AN OSRAM BUSINESS. ALL RIGHTS RESERVED. TRAXON™, TX CONNECT®, ARE TRADEMARKS OF TRAXON TECHNOLOGIES. U.S. PATENTS, E.U. PATENTS, JAPAN PATENTS, OTHER PATENTS PENDING. SPECIFICATIONS ARE SUBJECT TO CHANGE WITHOUT NOTICE.

OSRAM